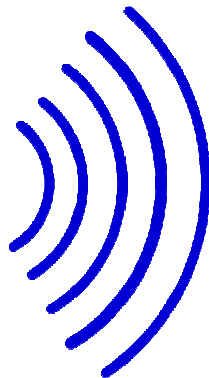

Table of Contents

1. Introduction	2
2.. Apparent of P-900 IoT station.....	5
3. Top case view and LED's function.....	6
4. Bottom case view and serial account number	7
5. Rear case view.....	8
6. Installation IoTStations APP for your system	9
7. Connect to internet.....	12
8. Addition the new IoT stations on line.....	13
9. Addition alarm devices on line.....	15
10. Reading alarm message, and alert sound setting.....	18
11. System reset.....	19
12. Specification	20

1. Introduction

Before, The POCSAG Transmitter can only call to pagers directly.



NOW ! The POCSAG Transmitter can still call to pagers directly and
At the same time via the P-900 IoTStation sends alarm message to your smart
phone .

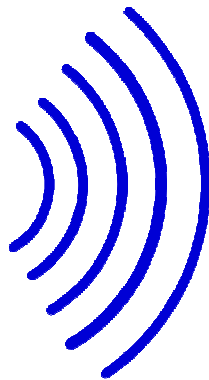

How it works? The P-900 IoT system !



- a. **Sub-1GHz POCSAG transmitter (148,315,433,426,457,868,915...MHz)**
such as our products Pendent TX, Watch TX, Alarm TX, Nurse call systems etc.
(Items from WDIT : M-810,M-820,M-840,WD2,M-838,M-909K,M-916, NP-14, EM-898.....)
- b. **P-900 IoTStation: When receives the POCSAG code, which will be transferred to internet through the Wi-Fi AP.**
- c. **Via Wi-Fi AP connect to Internet.**
- e. **Via internet sending the alarm message to your smart phones...**

2. Appearance of the P-900 IoTStation.



3. Top view of the case and LED functions.

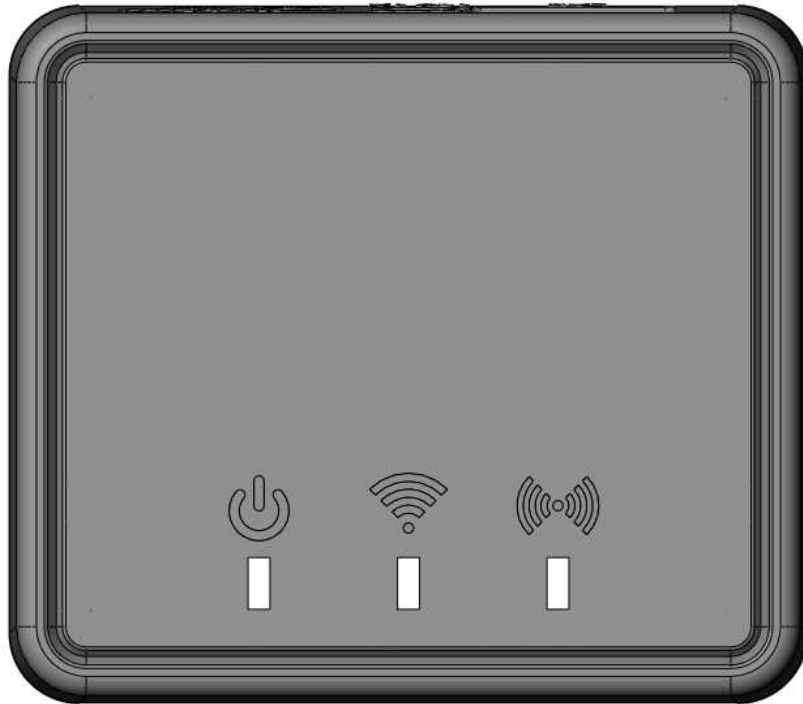

Power ON Indication

Indicate the power status: light would be on when power is on.



ON the Internet Indication

Indicate the Wi-Fi status: light would be on when connected to a Wi-Fi.



Wireless Communication indication

Indicate the sub-1GHz contact and system reset status:

Fast flash means the ready to make the system pairing; light for pairing accept.

4. Bottom view of the case and serial number etc...

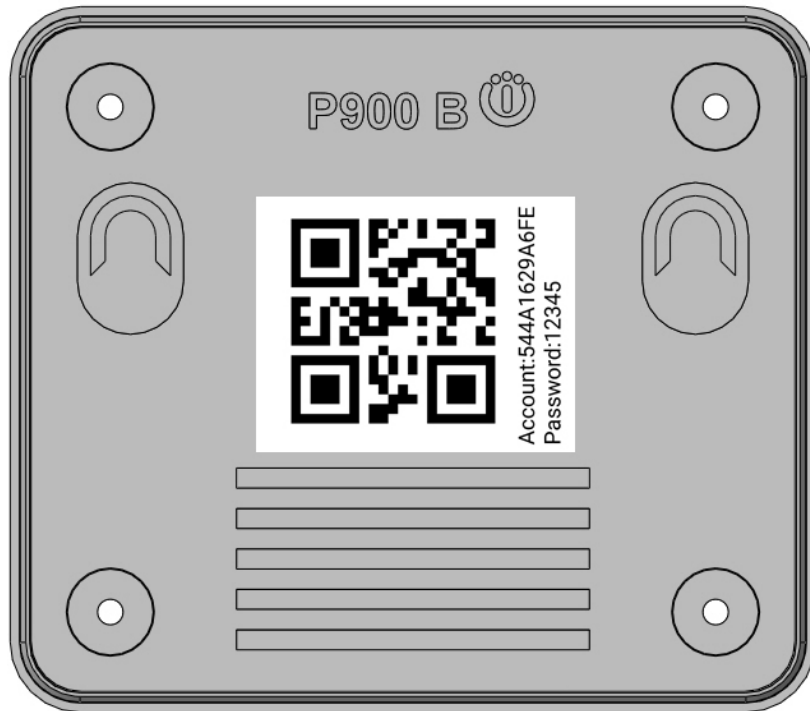

QR code icon

The QR code stickers on the rear case shows the account number for system registration and to help adding additional IoTStation into IoT APP of system.

5. Rear side view of the case:

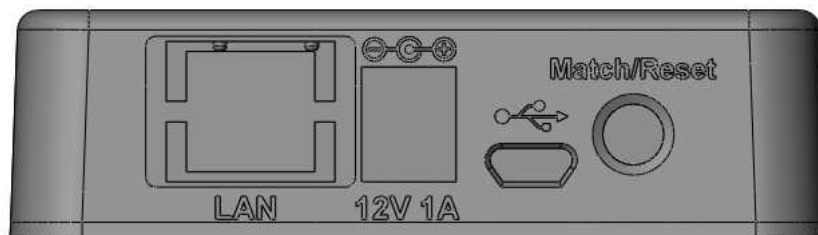

12V1A

The system power supply DC in connection: DC12V >0.5A

Micro USB Jack

For the firmware upgrade purpose and also for the dealers software programming.

Match/Reset button

To match the assigned transmitter devices pairing and for the system reset.

6. Installation of IoTStations App for system

6-1 Step1: Download APP from Internet

http://www.iotstations.com:8080/wd2web/WD2_Dvc_SetupRingTone.apk

Or

Use QR code reader to scan the QR code of the following via your smart phones

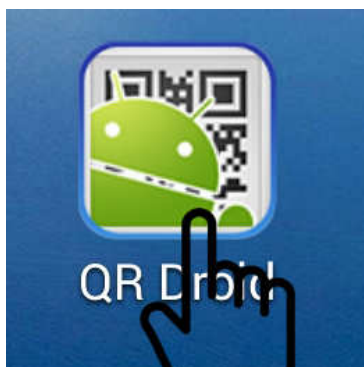

Please Download
the IoTstation App
for Android from
Here!



6-2. Step2: After completing download IoTStations APP. Then install the IoTStation app.

6-3. Step3: Open the IoTstation App and click on "Add Brand New Station"

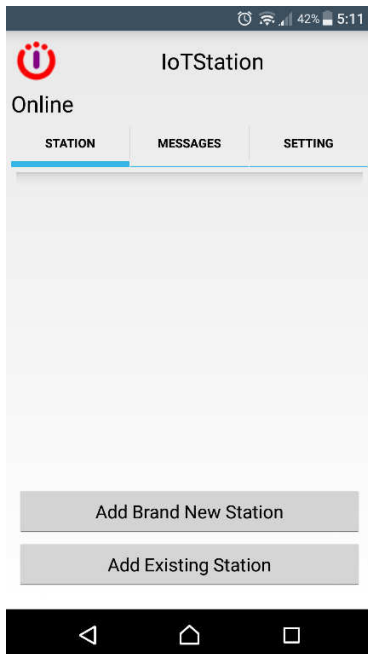

Please make sure your mobile device is connected to a WiFi, the same WiFi will be used to connect to IoTstation.

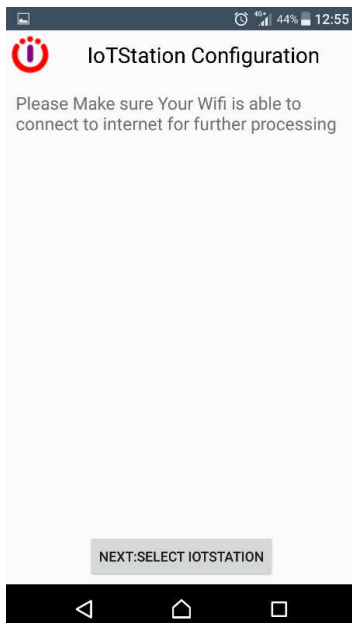

6-4. Step4: Click on "NEXT:SELECT IOTSTATION"

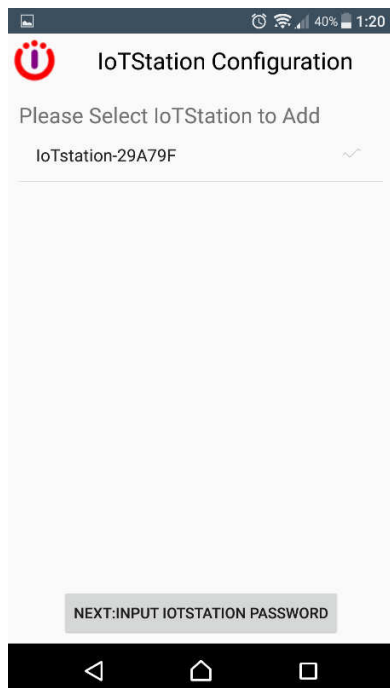

6-5. Step5: Select the IoTStation to add, and click on "NEXT:INPUT IOTSTATION PASSWORD"

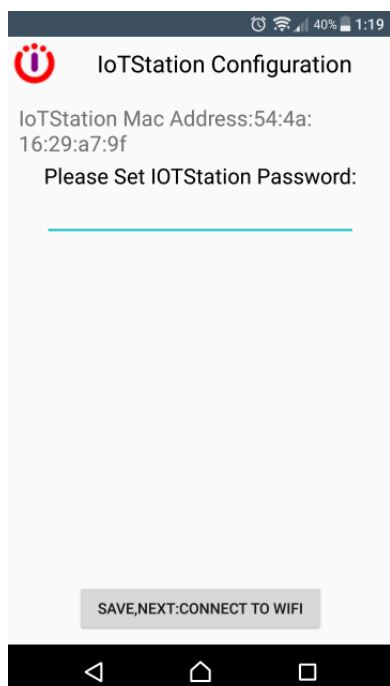

6-5. Step6: Please Set the Password for the IoTStation
Password can be set within 4-7 digits English and Number.

Then click on the "SAVE,NEXT:CONNECT TO WIFI".

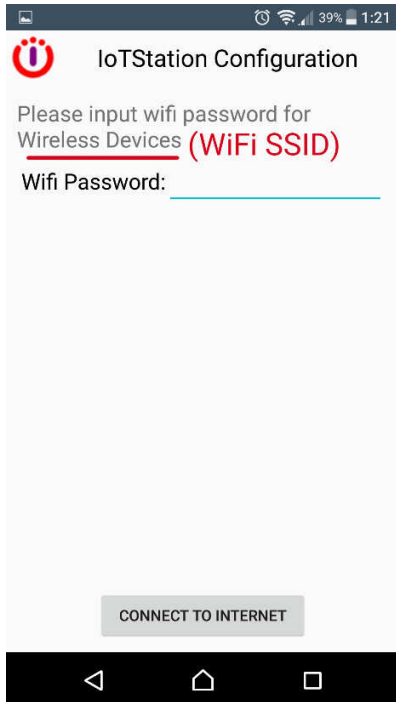

6-6. Step7:Please Enter the Password for your WiFi.

Then click on "CONNECT TO INTERNET".

After successfully setting the IoTStation, you should see a new IoTStation added here.

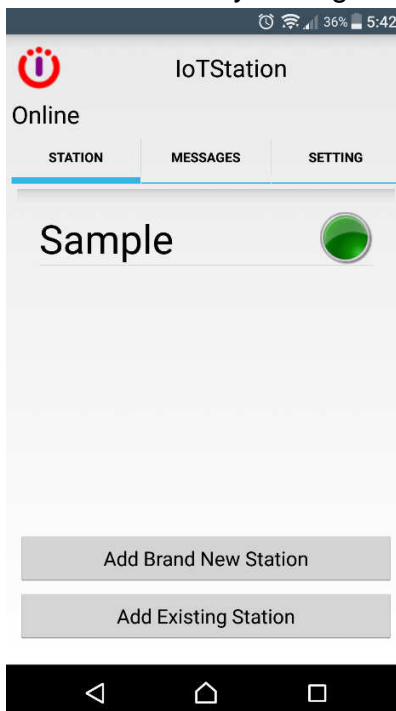

7. Add on additional IoTStation.

7-1. Click on "Add Existing Station"

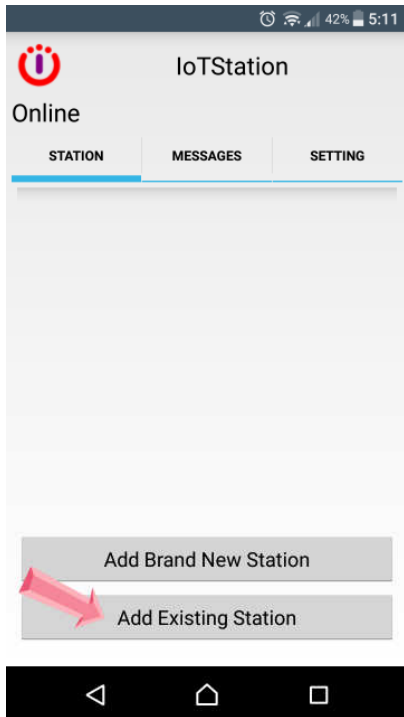

7-2. Use your smart phone to scan the QR code on the bottom side of IoTStation.

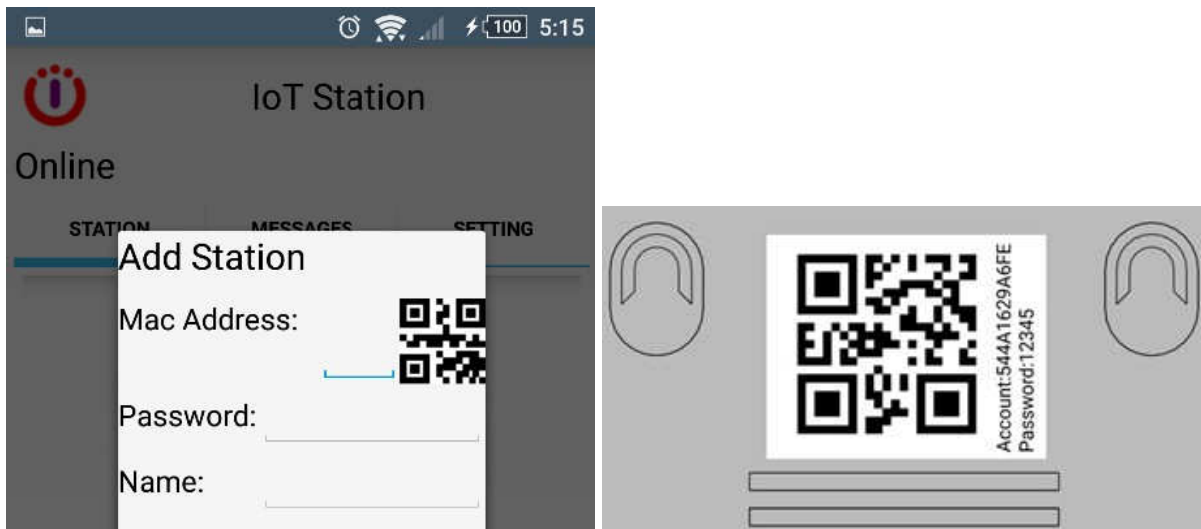

7-3. key-in the password into your screen...

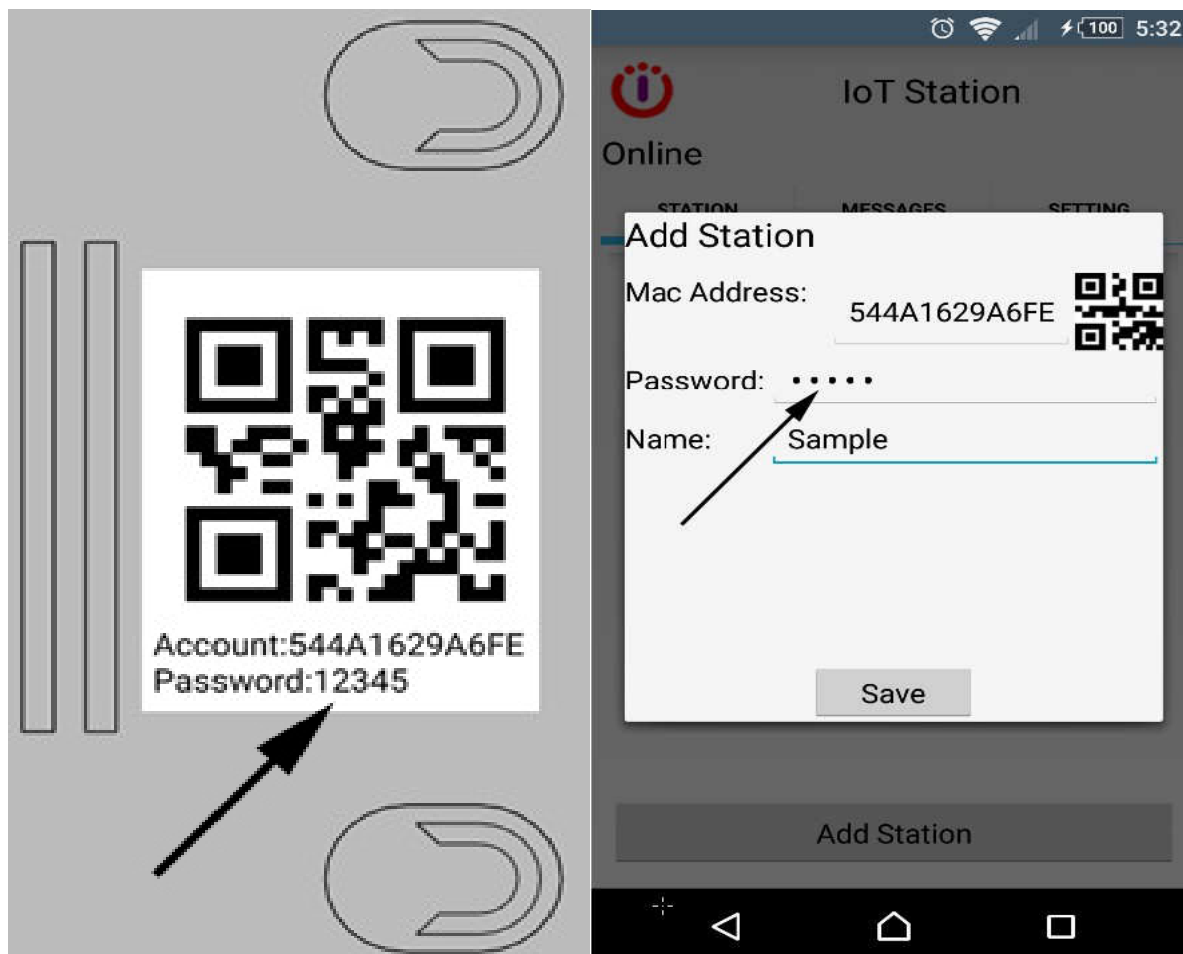

7-4. click [Save]..

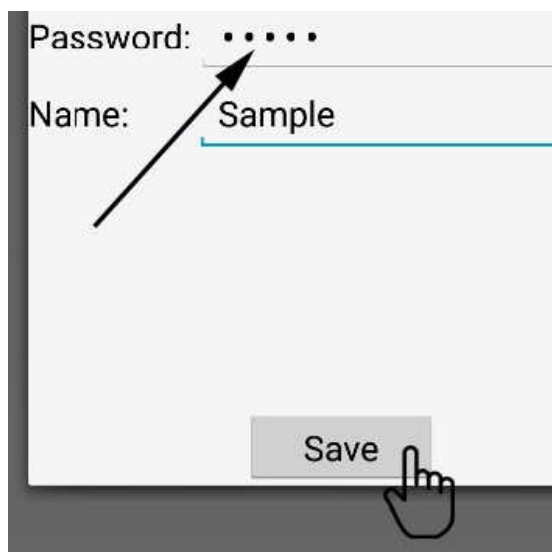

Successfully added the new IoTStation..

8. Add the alarm devices to the IoTStation.

8-1. Press the Match/Reset button on the side of IoTStation for one second, and the

 Sub-1Ghz led light will be blinking.

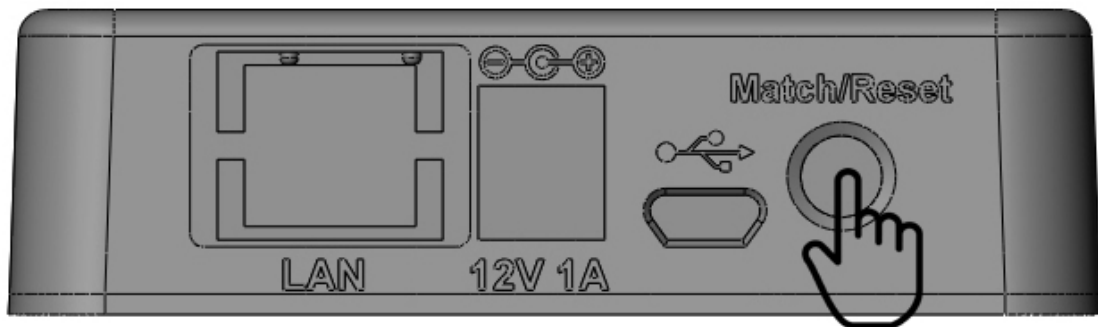

8-2. Press the transmitter's TX button and make transmitter devices an activity within 10 sec. If added successfully, the led light blinking will be stop.

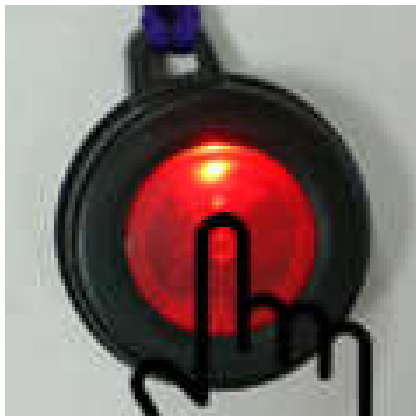

8-3. Test the peripheral and just add to activate the peripheral again. If added successfully, the mobile device should be getting a message.

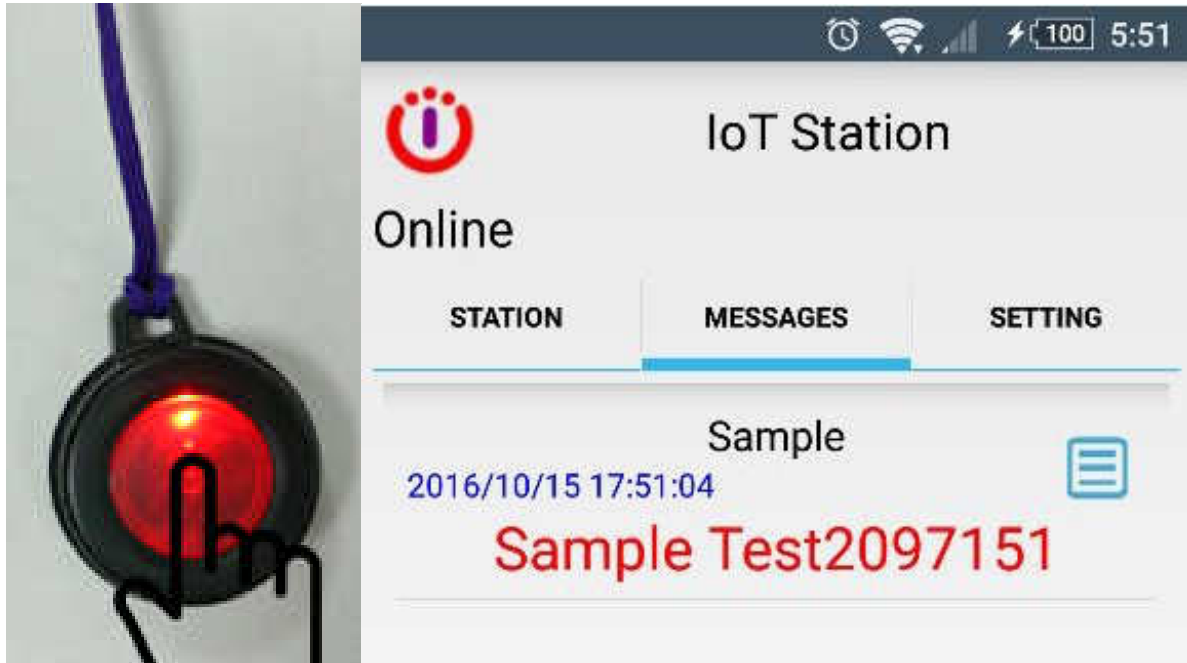

8-4. Rename the alarm messages, click on rename icon.

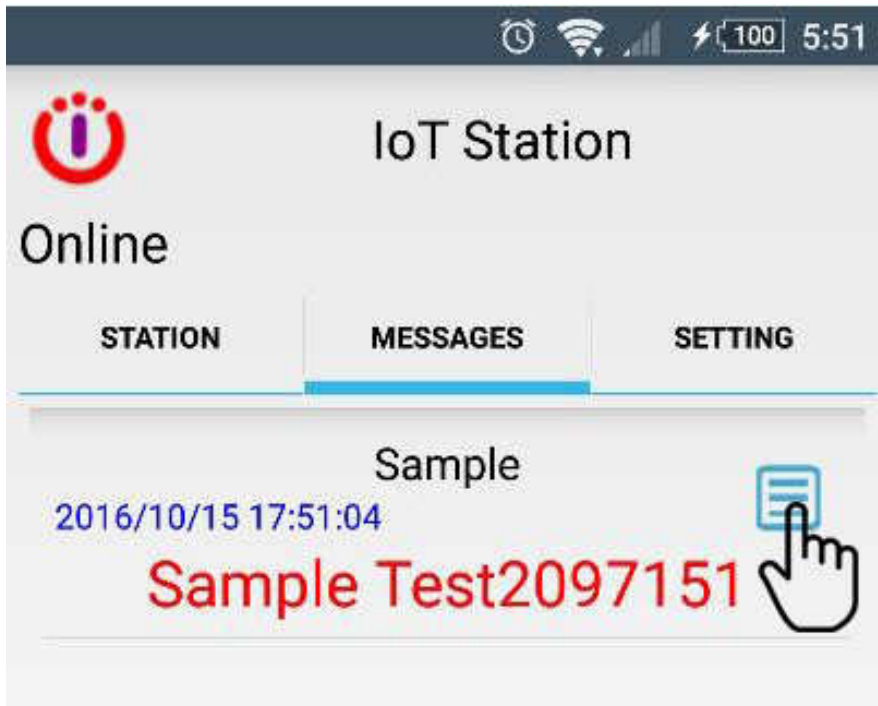

9-5. key-in the name of new alarm devices and then click [OK]

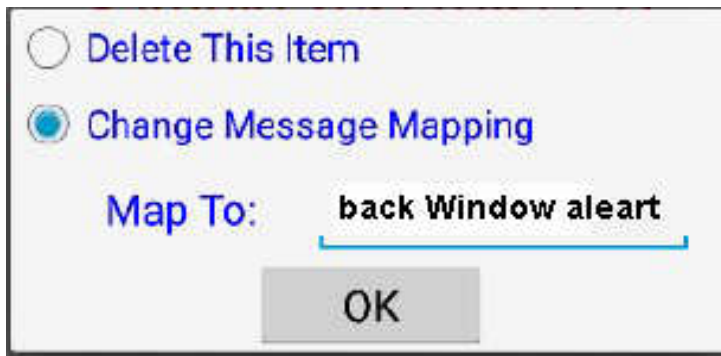

or



9. smart phone side setting

9-1. Click STATION for select your IoTStation,

Example: [My house],[Office],[warehouse],[daddy at home]...

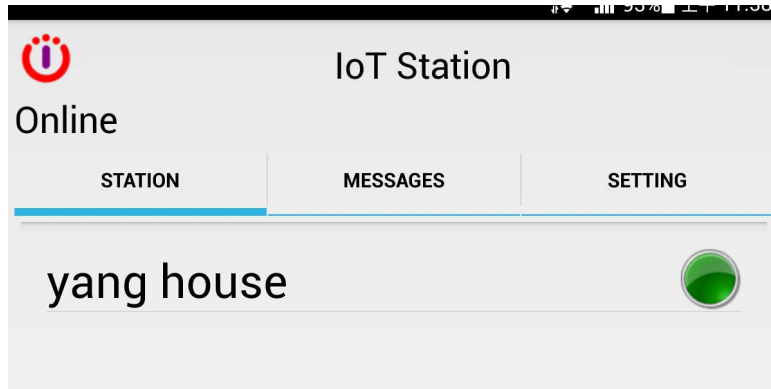

9-2. Click Message to view all alarm messages....

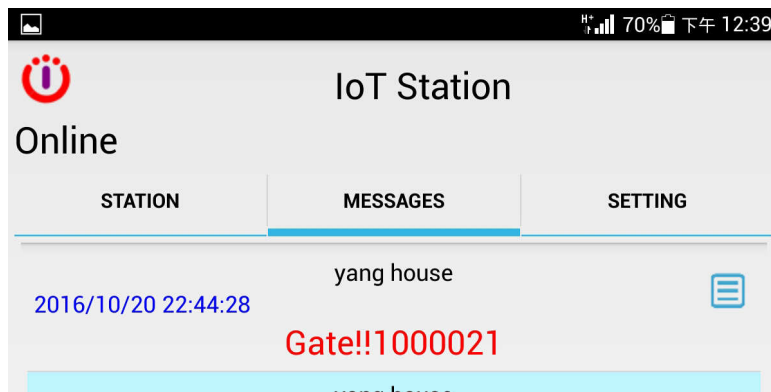

9-3. Click SETTING to set alarm Sound or/and Vibration...

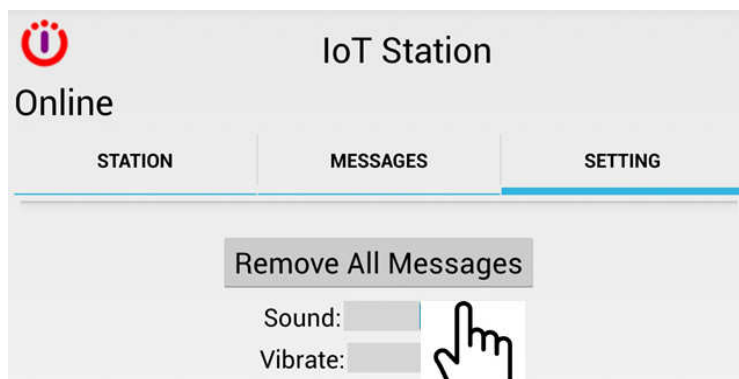

10. System reset.

10-1: When you are confused or missing of the system setup,

You can press Match/Reset button over 15 Seconds until the beep sound to release the button to reset the factory setting, and try again.

(When reset is activated, IoTStation would go back to default setting)

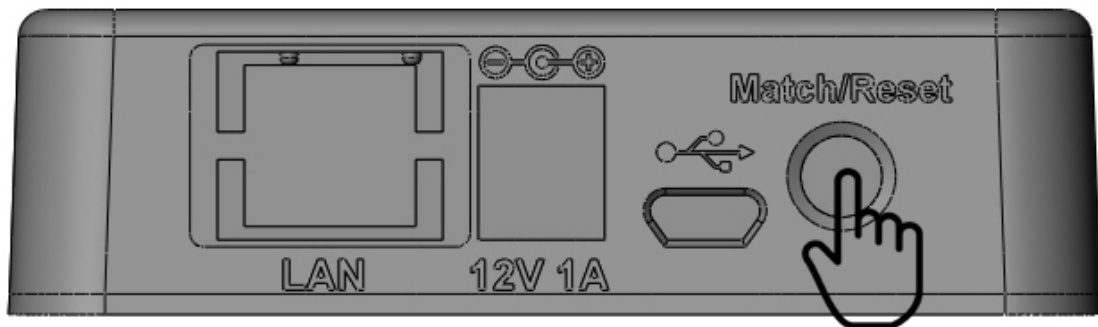

P-900 IoT Stations Specification	
General	
Operation temperature	-25°C ~ 70°C
Power Supply	DC 12V 0.5-2A
Case size:	80(L) x 70(W) 27(H) mm
Weight:	220g without AC adapter.

Wi-Fi Section	
Wi-Fi Standard	802.11 b/g/n
Network Mode	AP / Station
Transmission Rate	802.11b: 11Mbps 802.11g: 54Mbps 802.11n: 54Mbps
Transmitter Power	17.0 dbm @ 1 DSSS 17.25 dbm @ 11CCK 13.5 dbm @ 54 OFDM
Receiver Sensitivity	-94 dbm @ 1DSSS -87 dbm @ 11 CCK -73 dbm @ 54 OFDM
Frequency	2.412 - 2.484 GHz
Security Mechanism	Security: WEP-A/WPA-PSK/WPA2-PSK Encryption:WEP64/WEP128/TKIP/AES
Antenna	Internal on-board antenna

Sub 1 GHz POCSAG Section	
Data Format	POCSAG CCIR #1
Frequency	138-174MHz 430-470MHz 868-915MHz
Modulation	2FSK NRZ
Data Rate	512 bps/1200bps/2400bps
Receiver Sensitivity	-115dbm via loop antenna at 138-174MHz -113dbm via loop antenna at 430-450MHz -105dbm via loop antenna at 868-915MHz
Antenna	Internal Loop antenna

Document Number : WP900ANDMN170821E

Release Date : Feb.21.2017

