

## Sub-1GHz to Internet

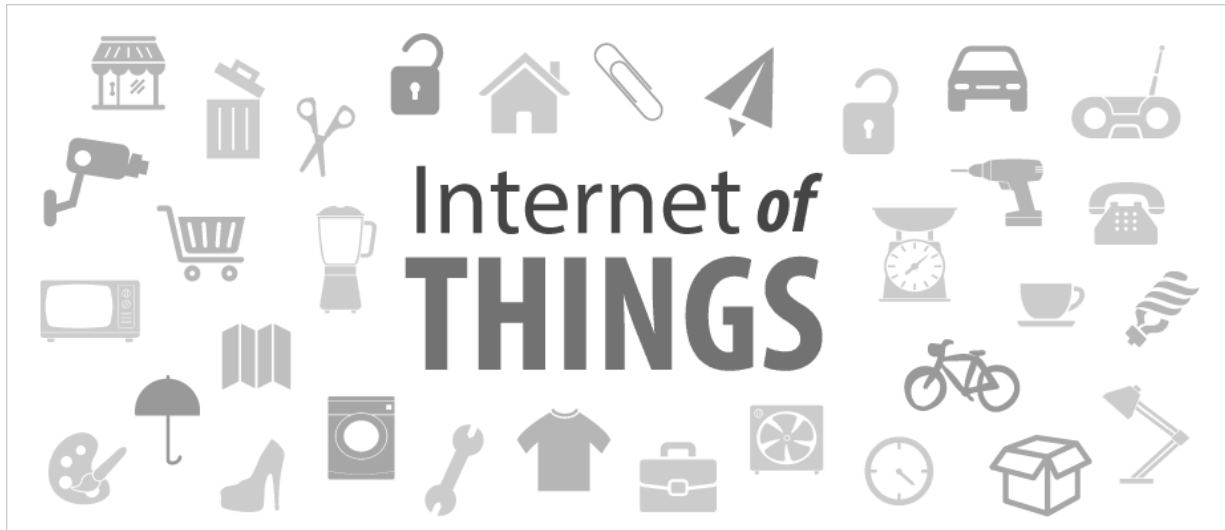

### P-900 IoT Gateway.

Operation Manual

[Version 3.3]



Connect POCSAG to Internet by WIFI and receive by smart phone.



## Table of Contents

1. Introduction .....	2
2.. Apparent of P-900 IoT station.....	5
3. Top case view and LED's function.....	6
4. Bottom case view and serial account number .....	7
5. Rear case view.....	8
6. Installation IoTStations APP for your system .....	9
7. Connect to internet.....	12
8. Addition the new IoT stations on line.....	13
9. Addition alarm devices on line.....	15
10. Reading alarm message, and alert sound setting.....	18
11. System reset.....	19
12. Specification .....	20

# 1. Introduction

*The Take care system, Fire alarm, Security system, food service calling.... can be directly sending urgent message to own smartphones....*

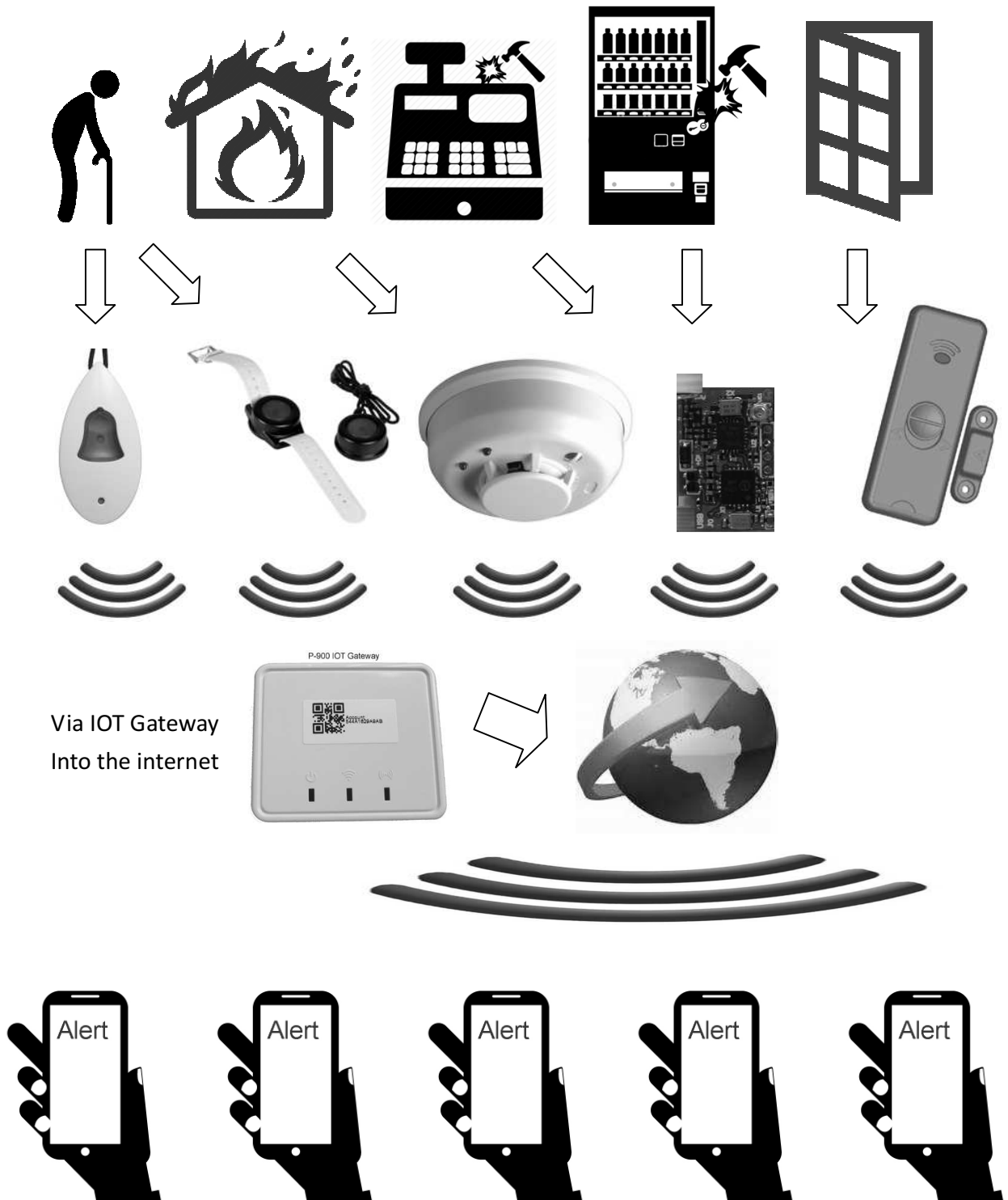

### 1-1 One Gateway P-900 can be connected to many smartphones....

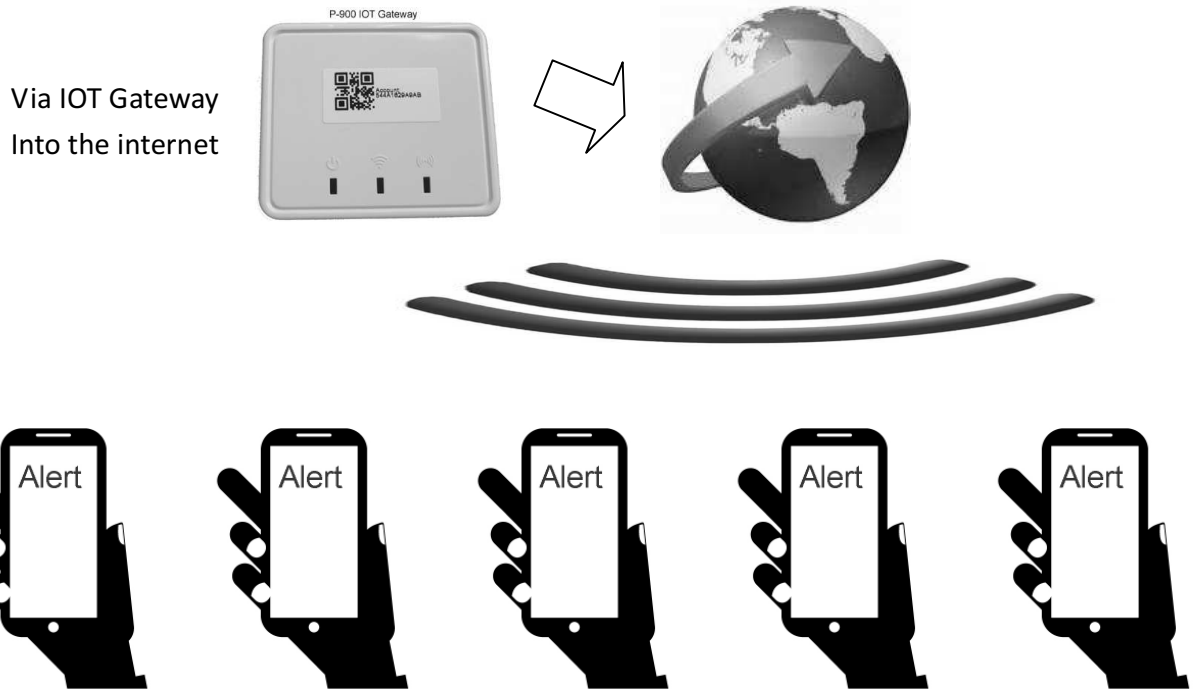

Up to 256 smart phones can received from 1 P-900 IoT Gateway

### 1-2 One smart phones can received message from many P-900 IoT Gateways

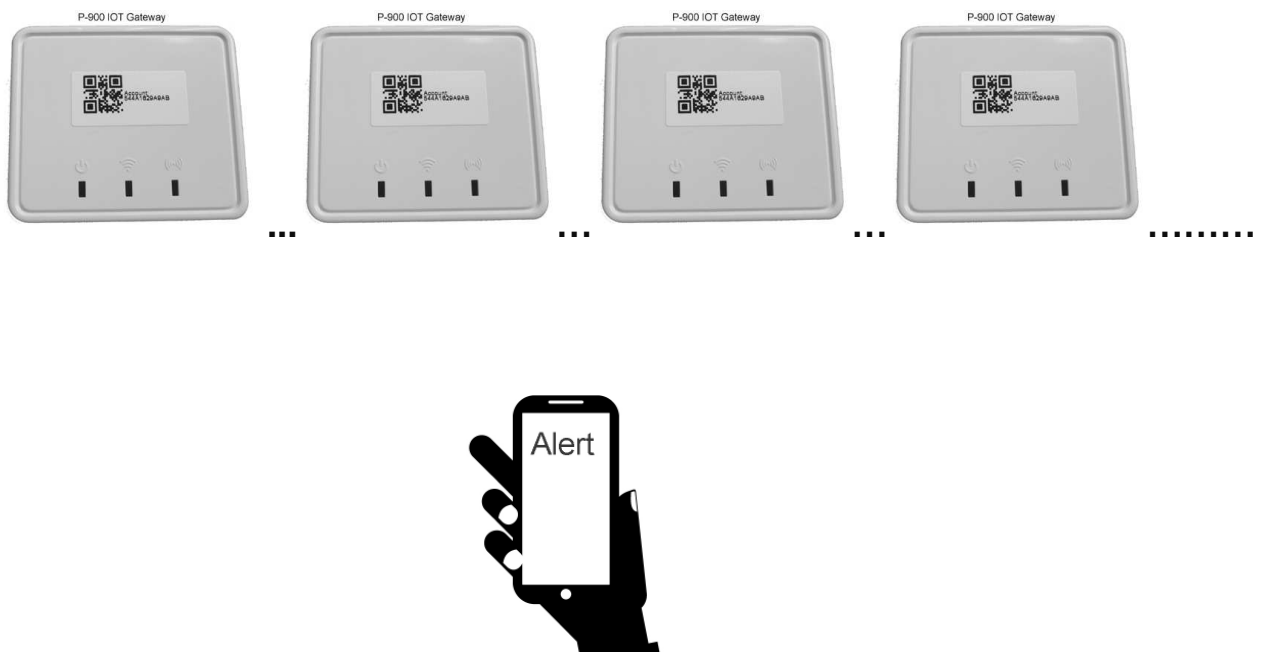

## ***How it works? The P-900 IoT system !***



- a. **Sub-1GHz POCSAG transmitter (148,315,433,426,457,868,915...MHz)**  
such as our products Pendant TX, Watch TX, Alarm TX, Nurse call systems  
POCSAG Transmitter modules..etc.  
(Like Items from WDIT :M-810,M-820,M-840,WD2,M-838,M-909K,M-916,  
NP-14, EM-898,w009 modules.....)
- b. **P-900 IoT gateway: When receives the POCSAG code, which will be transferred to internet through the Wi-Fi AP.**
- c. **Via Wi-Fi AP connect to Internet.**
- e. **Via internet by Wi-Fi or by GSM, 3G,4G, LTE, global mobile phone system....sending the alarm message to your smart phones...**

**2. Appearance of the P-900 IoTStation.**



### 3. Top view of the case and LED functions.

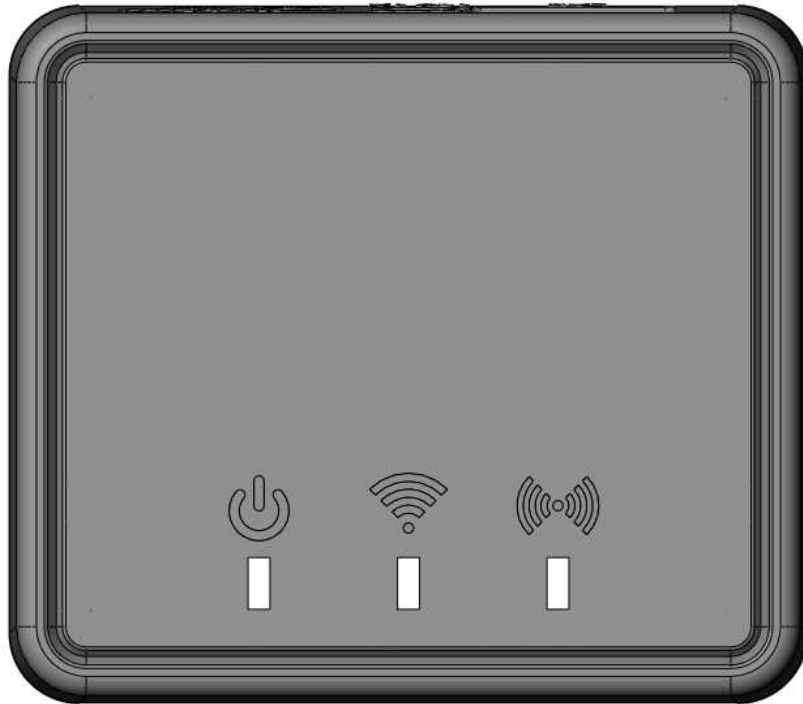

#### **Power ON Indication**

Indicate the power status: light would be on when power is on.



#### **ON the Internet Indication**

Indicate the Wi-Fi status: light would be on when connected to a Wi-Fi.



#### **Wireless Communication indication**

Indicate the sub-1GHz contact and system reset status:

Fast flash means the ready to make the system pairing; light for pairing mode.

#### 4. Bottom view of the case and serial number etc...

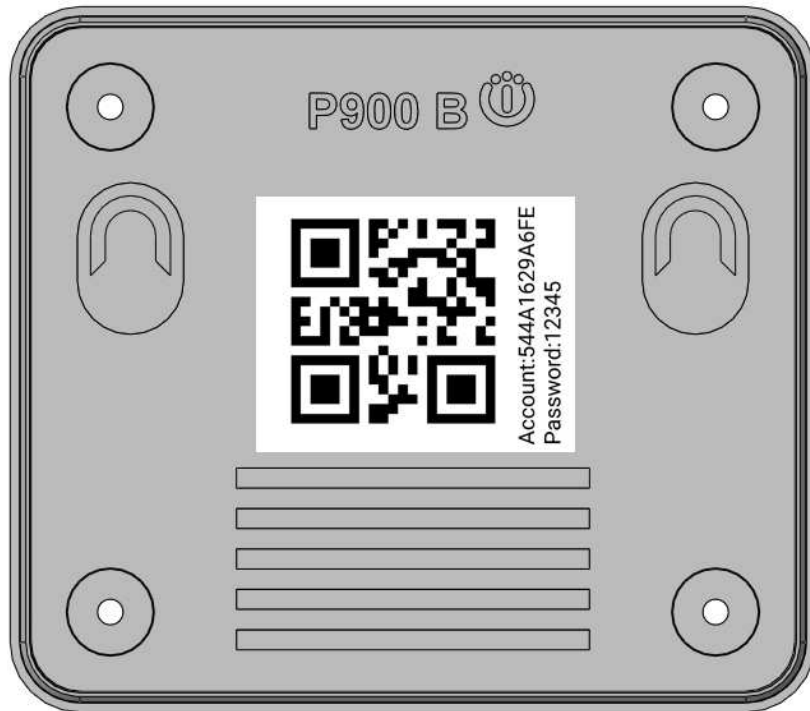

#### QR code icon

The QR code stickers on the rear case shows the account number for system registration

Plus more and more smart phone into the system.

Just take this QR code by the phones.



## 5. Rear side view of the case:

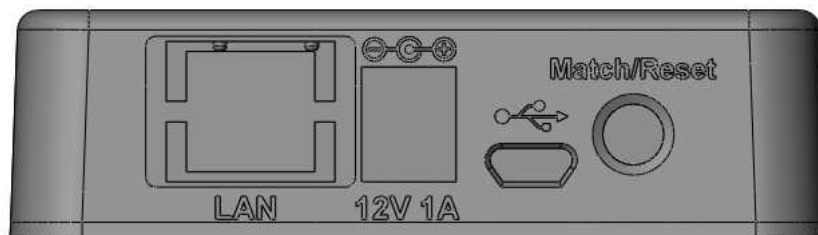

### **12V1A**

The system power supply DC in connection: DC12V >0.5A

### **Micro USB Jack**

For the firmware upgrade purpose and also for the dealers software programming.

### **Match/Reset button**

To match the assigned transmitter devices pairing and for the system reset.

## 6. Installation of IoTStations App for system

6-1 Step1: Download APP by QR code

Use QR code reader to scan the QR code of the following via your smart phones



Please Download  
the App for  
Android from here!  
17/03/24

*Usually the latest APP QR  
code will sticker on the top of  
packing box*



6-2. Step2: After completing download IoTStations APP. Then install the IoTStation app.

6-3. Step3: Open the IoTstation App and click on "Add Brand New Station"

(1<sup>st</sup> time to set-up must click Add brand New.....)

Also plug new one and more one click Add Existing ststion(s).

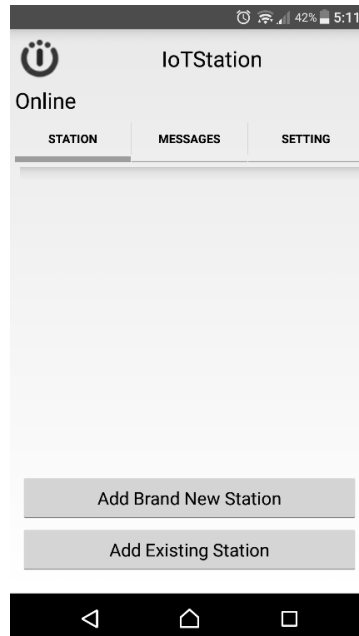
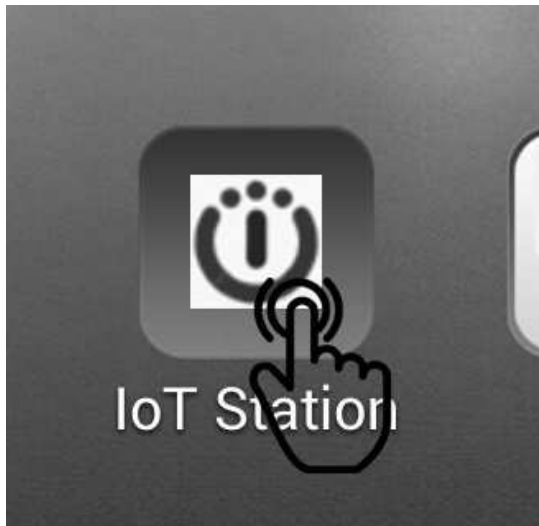

Please make sure your mobile device is connected to a WiFi, the same WiFi will be used to connect to IoTstation.

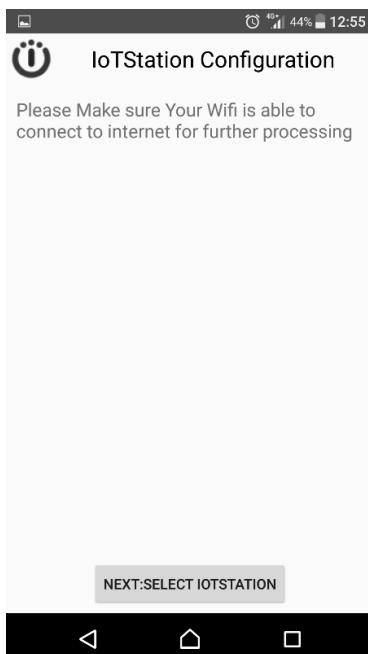

6-4. Step4: Click on "NEXT:SELECT IOTSTATION"

6-5. Step5: Select ✓ the IoTStation to add, and click on "NEXT:INPUT IOTSTATION PASSWORD"

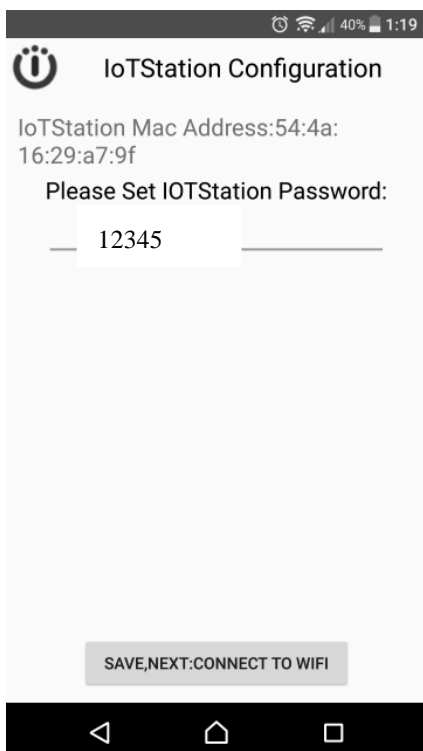
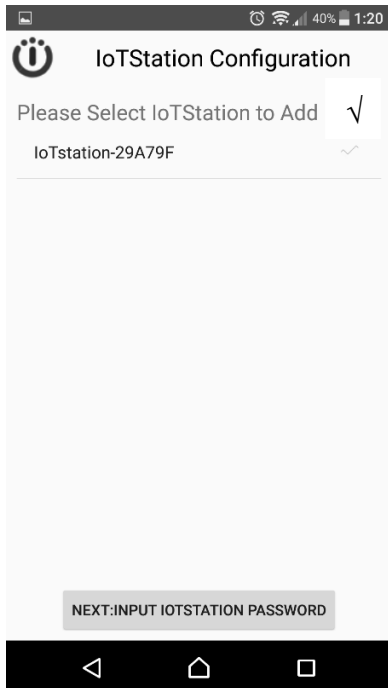

6-5. Step6: Please Set the Password for the IoTStation  
*Password can be set within 4-7 digits English and Number.*

Then click on the "SAVE,NEXT:CONNECT TO WIFI".



6-6. Step7:Please Enter the Password for your Wi-Fi.

See your Wi-Fi password. Then key-in that. and click [Connect to internet].

If the Wi-Fi A/P no need password just click [Connect to internet].

After successfully setting the IoTStation, you should see a new IoTStation added here.

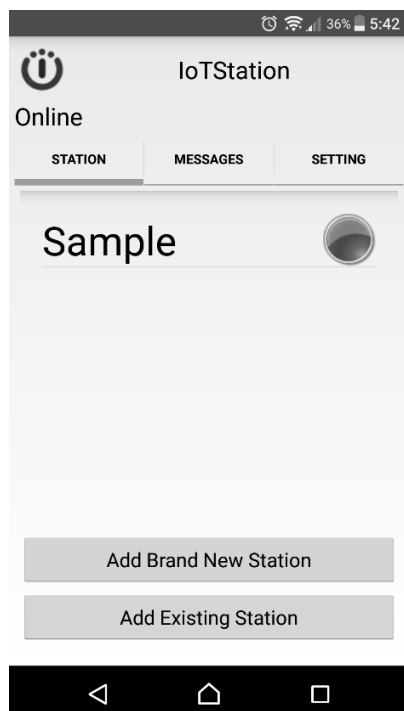

## 7. Add more smartphone on your IoTStation.

7-1. Click on “Add Existing Station”

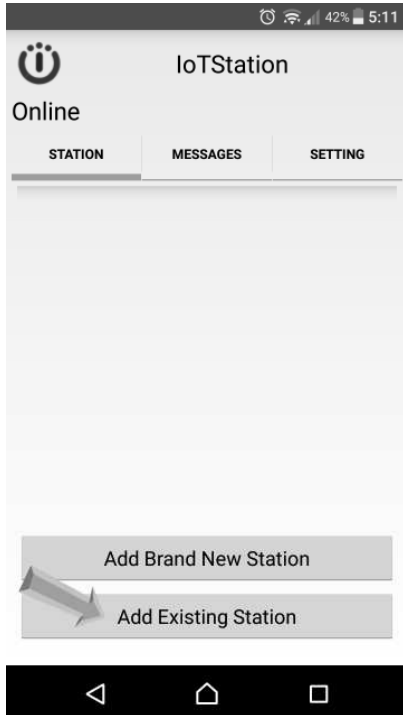

7-2. Use your smart phone to scan the QR code on the bottom side of IoTStation.

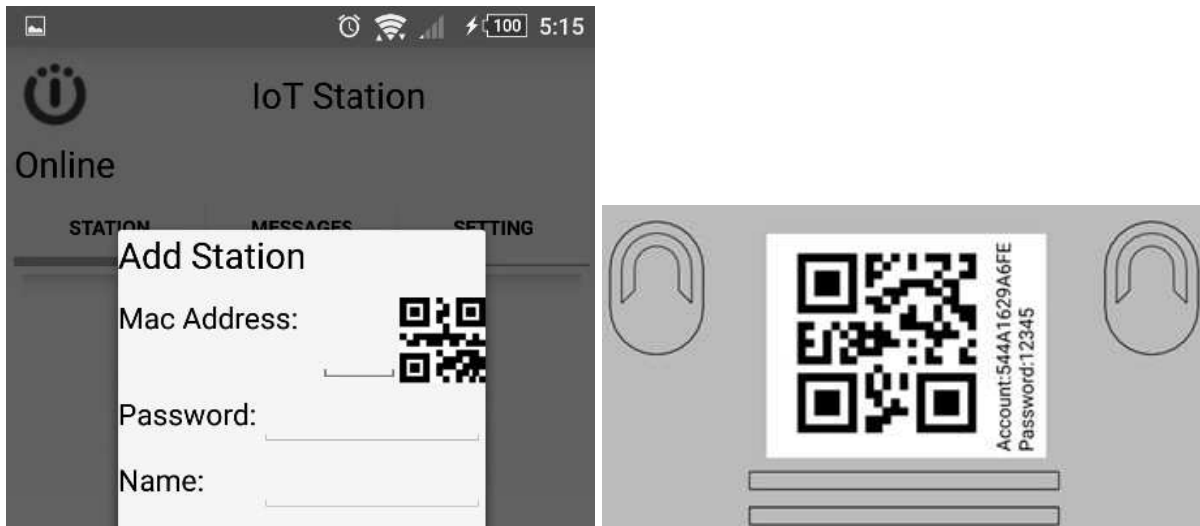

7-3. key-in the password into your screen...

This password must same with Item 6-5 (page 11) your set-up before.



7-4. click [Save]..

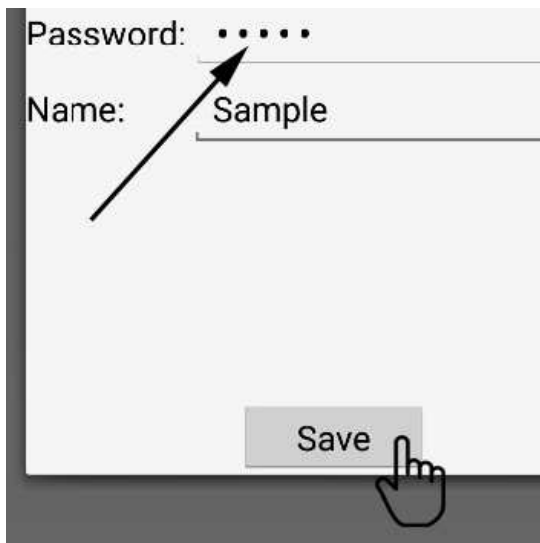

Success fully added the new smartphone on your IoT station.

## 8. Pairing alarm devices to the IoTStation.

8-1. Press the Match/Reset button on the side of IoTStation for one second, and the

- Sub-1Ghz led light will be blinking.
- (Maximum limited 999 PCS alarm devices can be set-up into 1 IoTStation)

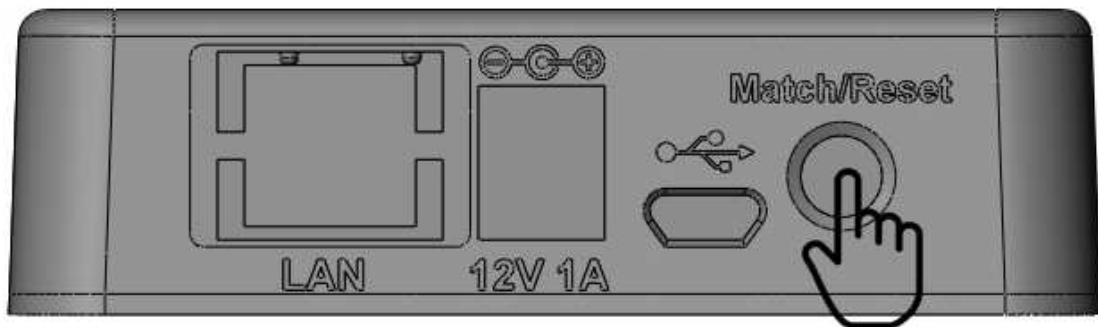

8-2. Press the transmitter's TX button and make transmitter devices an activity within 10 sec. If added successfully, the led light blinking will be stop.



If need to increase more alarm devices into your IoTStation  
Please repeater again by item 8-1



8-3. For test. Press active alarm devices again. If added successfully, the mobile device should be getting a message.

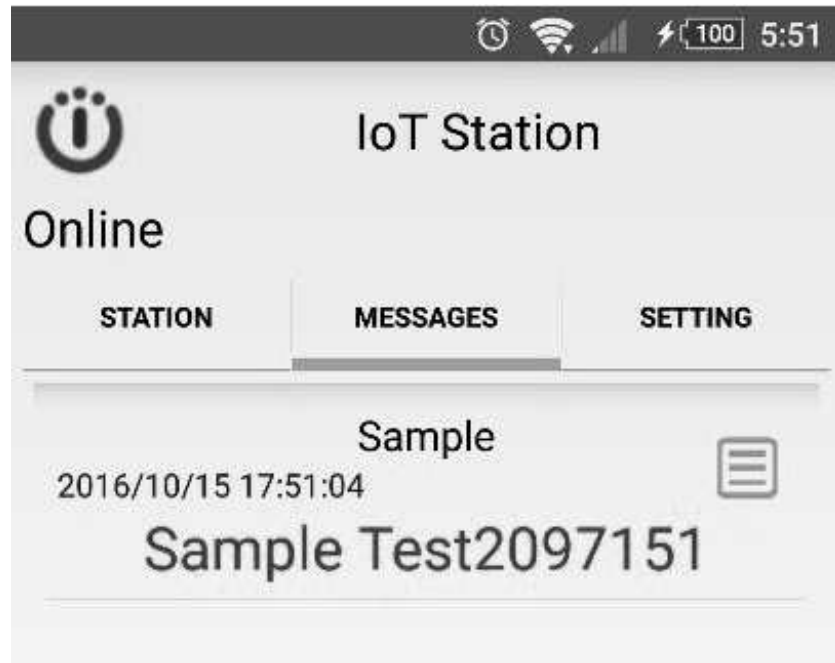

8-4. Rename the alarm devices, click on rename icon.

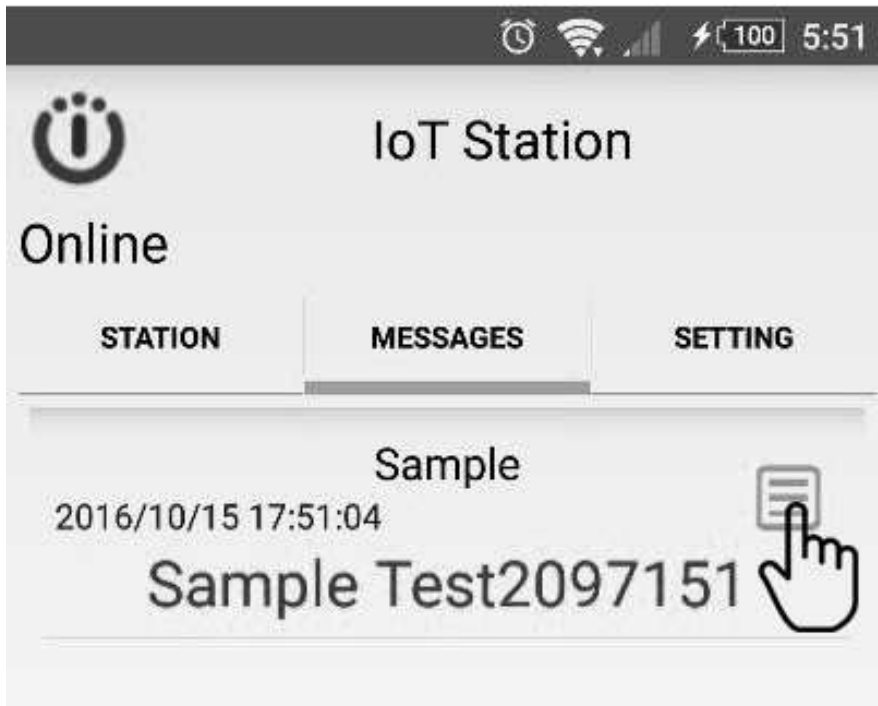

9-5. key-in the name of alarm devices and then click [OK]

examples: [Case Box alarm],[Door is open],[Daddy calling]....

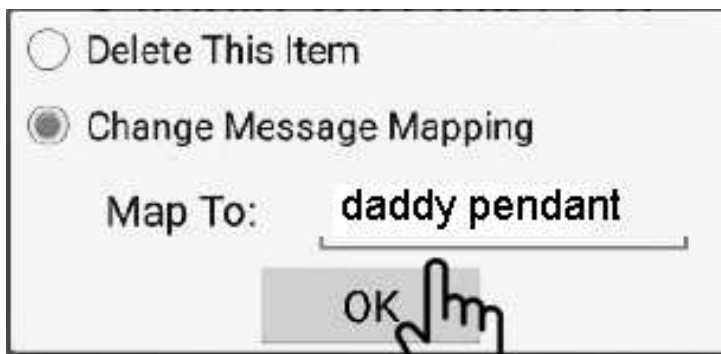

## 9. smart phone side setting

9-1. Click STATION for select your IoTStation,

Example: [My house],[Office],[warehouse],[daddy at home]...

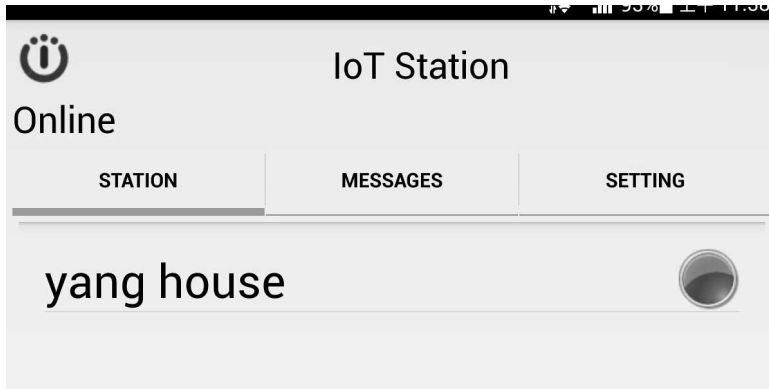

9-2. Click Message to view all alarm messages....

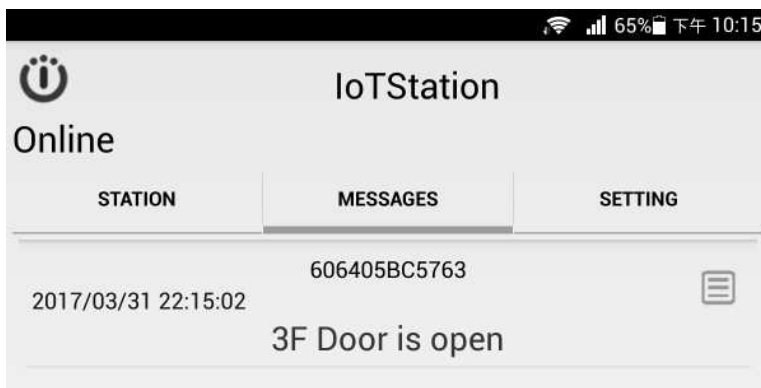

9-3. Click SETTING to set alarm Sound or/and Vibration...



## 10. System reset.

10-1: When you are confused or missing of the system setup,

You can press Match/Reset button over 15 Seconds until the beep sound to release the button to reset the factory setting, and try again.

(When reset is activated, IoTStation would go back to default setting)

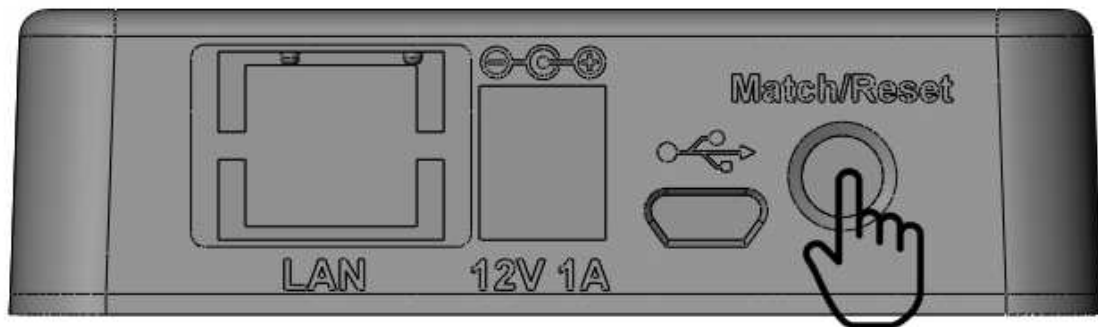

P-900 IoT Stations Specification	
General	
Operation temperature	-25°C ~ 70°C
Power Supply	DC 12V 0.5-2A
Case size:	80(L) x 70(W) 27(H) mm
Weight:	220g without AC adapter.

Wi-Fi Section	
Wi-Fi Standard	802.11 b/g/n
Network Mode	AP / Station
Transmission Rate	802.11b: 11Mbps 802.11g: 54Mbps 802.11n: 54Mbps
Transmitter Power	17.0 dbm @ 1 DSSS 17.25 dbm @ 11CCK 13.5 dbm @ 54 OFDM
Receiver Sensitivity	-94 dbm @ 1DSSS -87 dbm @ 11 CCK -73 dbm @ 54 OFDM
Frequency	2.412 - 2.484 GHz
Security Mechanism	Security: WEP-A/WPA-PSK/WPA2-PSK Encryption: WEP64/WEP128/TKIP/AES
Antenna	Internal on-board antenna

Sub 1 GHz POCSAG Section	
Data Format	POCSAG CCIR #1
Frequency	138-174MHz 430-470MHz 868-915MHz
Modulation	2FSK NRZ
Data Rate	512 bps/1200bps/2400bps
Receiver Sensitivity	-115dbm via loop antenna at 138-174MHz -113dbm via loop antenna at 430-450MHz -105dbm via loop antenna at 868-915MHz
Antenna	Internal Loop antenna

Document Number : WP900ANDMN171541E

Release Date : April.13.2017

